



BM 124 (E-Klasse)
(1985 → 1995)

Limousine 200 → 320 E (E 320)
Limousine 200 D → 300 D (E 300)

Quality Made For The World

(ex.) Sport / 4-matic

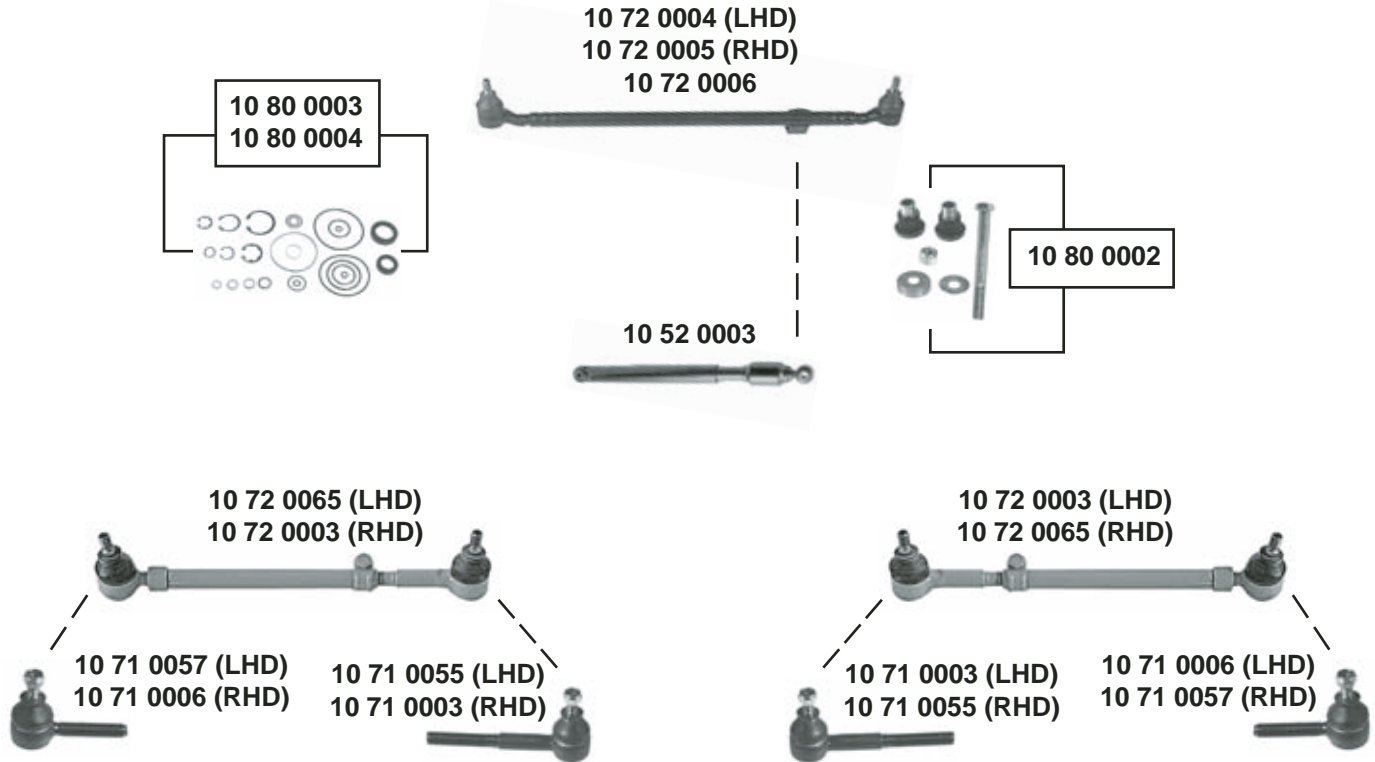

(1) 260 E / 280 E (E 280) / 300 E / 300 E-24
320 E (E 320)
250 D (E 250) / 250 D Turbo (E 250)
300 D (E 300) / 300 D Turbo (E 300)

(2) 200 / 200 E (E 200) / 220 E (E 220) / 230 E
200 D (E 200)

SWAG	Ref. - No.			
10 52 0003	124 463 04 32	Lenkungsdämpfer / steering damper		
10 71 0003	000 338 59 10	Spurstangenendstück / tie rod end		M14x1,5 LHT
10 71 0006	000 338 54 10	Spurstangenendstück / tie rod end		M14x1,5 RHT
10 71 0055	000 338 56 10	Spurstangenendstück / tie rod end		M14x1,5 LHT
10 71 0057	000 338 51 10	Spurstangenendstück / tie rod end		M14x1,5 RHT
10 72 0003	124 330 09 03	Spurstange / tie rod		
10 72 0004	124 460 08 05	Lenkstange / drag link	(ch.) → 1B 022104	
10 72 0005	124 460 09 05	Lenkstange / drag link	(ch.) → 2B 051198	
10 72 0006	124 460 12 05	Lenkstange / drag link	(ch.) 1B 022104 →	
10 72 0006	124 460 12 05	Lenkstange / drag link	(ch.) 2B 511198 →	
10 72 0065	124 330 08 03	Spurstange / tie rod		
10 80 0002	124 460 01 19	Rep. Satz Lenkhebel / rep. kit steering arm		
10 80 0003	124 460 01 61	Rep. Satz Servolenkung / rep. kit power steering	(1)	
10 80 0004	201 460 00 61	Rep. Satz Servolenkung / rep. kit power steering	(2)	



BM 124 (E-Klasse)
(1985 → 1995)

Limousine 200 → 320 E (E 320)

Limousine 200 D → 300 D (E 300)

(ex.) Sport / 4-matic

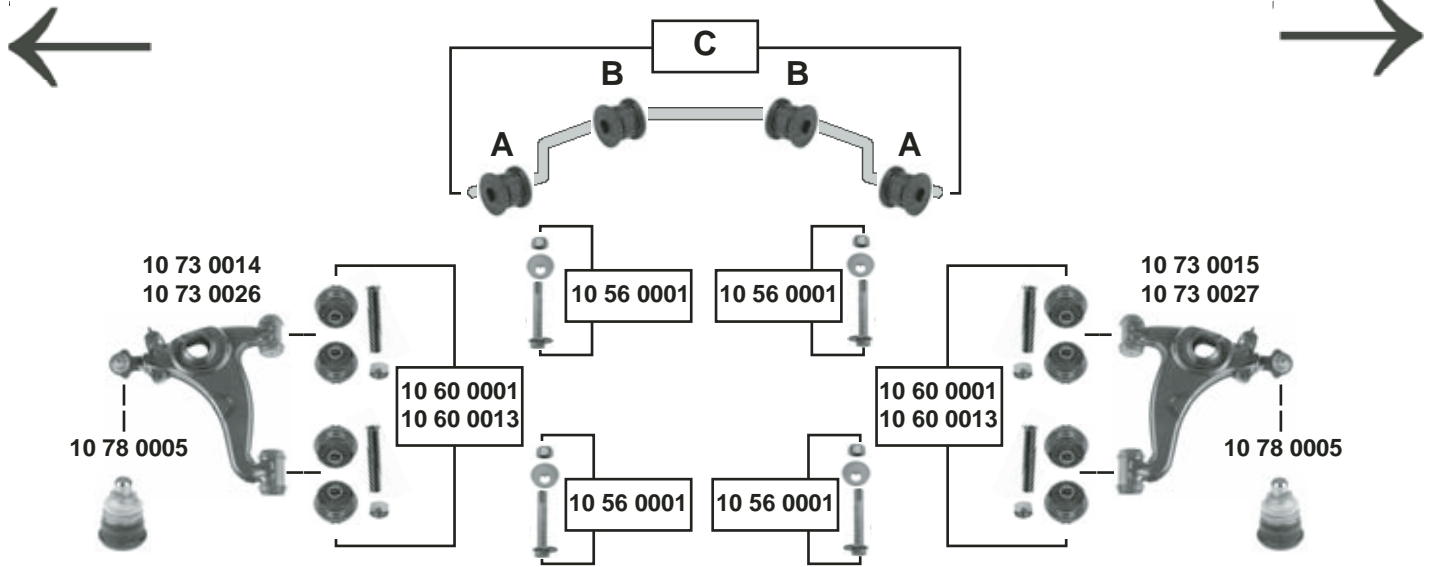

Stabilisatorlager / stabilizer mounts

	A	B	C		A	B	C
200 / 200 E → 10/92 (ch.) → A 204766	10 61 0034	10 61 0033	10 61 0051	200 D → 07/93 (ch.) → A 204766	10 61 0034	10 61 0033	10 61 0051
(ch.) A 204767 →	10 61 0032	10 61 0033	10 61 0030		(ch.) A 204767 →	10 61 0032	10 61 0033
200 E (E 200) 10/92 →	10 61 0032	10 61 0041	10 61 0054	200 D (E 200) 07/93 →	10 61 0032	10 61 0041	10 61 0054
220 E / (E 220)	10 61 0032	10 61 0041	10 61 0054	250 D / D Turbo (E 250)	10 61 0032	10 61 0035	10 61 0055
230 E (ch.) → A 204766	10 61 0034	10 61 0033	10 61 0051	300 D / D Turbo (E 300)	10 61 0032	10 61 0035	10 61 0055
(ch.) A 204767 →	10 61 0032	10 61 0033	10 61 0030				
260 E / 280 E (E 280)	10 61 0032	10 61 0035	10 61 0055				
300 E / E-24 / 320 E (E 320)	10 61 0032	10 61 0035	10 61 0055				



(1) (ex.) 300 E -24 / 320 E (E 320)
(ex.) AMG 300 E 3.4 / E36 AMG

(2) 300 E -24 / 320 E (E 320)
AMG 300 E 3.4 / E36 AMG



Ref. - No.



10 56 0001	201 330 00 18	Rep. Satz Exzenterbolzen / rep. kit eccentric pin		M14x1,5x130
10 60 0001	124 330 05 75	Rep. Satz Querlenker / rep. kit control arm	(ch.) → B 711095	
10 60 0013	124 330 06 75	Rep. Satz Querlenker / rep. kit control arm	(ch.) B 711096 →	
10 61 0030	124 320 21 47	Rep. Satz Stabilisatorlager / rep. kit stabilizer mount		
10 61 0032	124 323 49 85	Stabilisatorlager / stabilizer mount		☒ I 18
10 61 0033	124 323 37 85	Stabilisatorlager / stabilizer mount		☒ I 24
10 61 0034	201 323 49 85	Stabilisatorlager / stabilizer mount		☒ I 23
10 61 0035	124 323 56 85	Stabilisatorlager / stabilizer mount		☒ I 26,5
10 61 0041	124 323 54 85	Stabilisatorlager / stabilizer mount		☒ I 24
10 61 0051	124 320 18 47	Rep. Satz Stabilisatorlager / rep. kit stabilizer mount		
10 61 0054	124 323 54 85 S1	Rep. Satz Stabilisatorlager / rep. kit stabilizer mount	(1)	
10 61 0055	124 323 56 85 S1	Rep. Satz Stabilisatorlager / rep. kit stabilizer mount	(1)	
10 73 0014	124 330 30 07	Querlenker / control arm	(2)	
10 73 0015	124 330 31 07	Querlenker / control arm	(2)	
10 73 0026	124 330 34 07	Querlenker / control arm	(2)	
10 73 0027	124 330 35 07	Querlenker / control arm	(2)	
10 78 0005	124 333 03 27	Traggelenk / ball joint	(1)	☒ A 18



BM 124 (E-Klasse)

(1985 → 1995)

Limousine 200 → 320 E (E 320) / Sport

Limousine 200 D → 300 D (E 300) / Sport

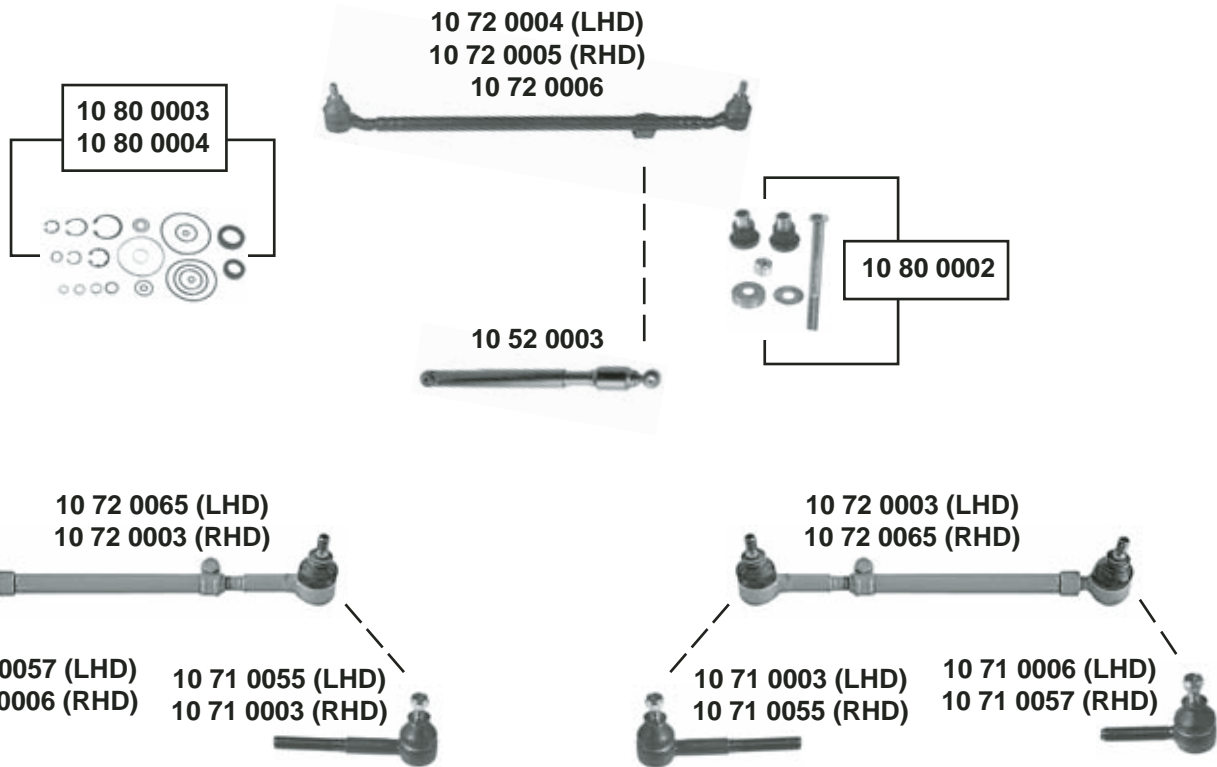

- (1) 260 E / 280 E (E 280) / 300 E / 300 E-24
 320 E (E 320)
 250 D (E 250) / 250 D Turbo (E 250)
 300 D (E 300) / 300 D Turbo (E 300)

- (2) 200 / 200 E (E 200) / 220 E (E 220) / 230 E
 200 D (E 200)

	Ref. - No.			
10 52 0003	124 463 04 32	Lenkungs­dämpfer / steering damper		
10 71 0003	000 338 59 10	Spurstangen­end­stück / tie rod end		M14x1,5 LHT
10 71 0006	000 338 54 10	Spurstangen­end­stück / tie rod end		M14x1,5 RHT
10 71 0055	000 338 56 10	Spurstangen­end­stück / tie rod end		M14x1,5 LHT
10 71 0057	000 338 51 10	Spurstangen­end­stück / tie rod end		M14x1,5 RHT
10 72 0003	124 330 09 03	Spurstange / tie rod		
10 72 0004	124 460 08 05	Lenkstange / drag link	(ch.) → 1B 022104	
10 72 0005	124 460 09 05	Lenkstange / drag link	(ch.) → 2B 051198	
10 72 0006	124 460 12 05	Lenkstange / drag link	(ch.) 1B 022104 →	
10 72 0006	124 460 12 05	Lenkstange / drag link	(ch.) 2B 511198 →	
10 72 0065	124 330 08 03	Spurstange / tie rod		
10 80 0002	124 460 01 19	Rep. Satz Lenkhebel / rep. kit steering arm		
10 80 0003	124 460 01 61	Rep. Satz Servolenkung / rep. kit power steering	(1)	
10 80 0004	201 460 00 61	Rep. Satz Servolenkung / rep. kit power steering	(2)	



BM 124 (E-Klasse) (1985 → 1995)

Limousine 200 → 320 E (E 320) **Sport**

Limousine 200 D → 300 D (E 300) **Sport**

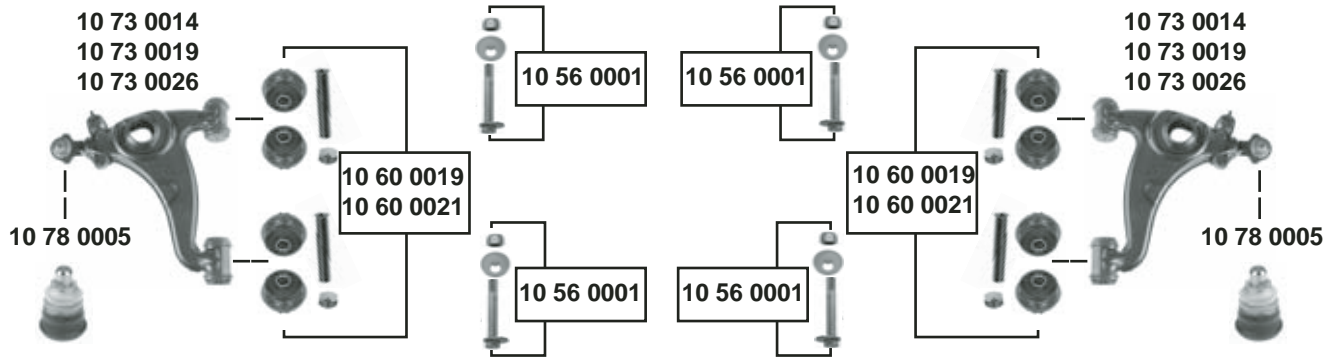
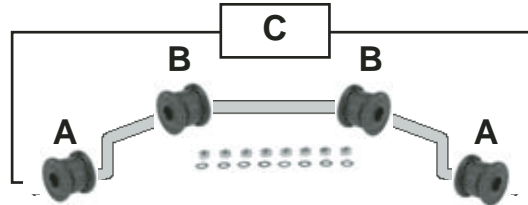

Stabilisatorlager / stabilizer mounts

	A	B	C		A	B	C
200 / 200 E (E 200)	10 61 0043	10 61 0045	10 61 0056	200 D (E 200)	10 61 0043	10 61 0045	10 61 0056
220 E (E 220) / 230 E	10 61 0043	10 61 0045	10 61 0056	250 D / D Turbo (E 250)	10 61 0043	10 61 0044	10 61 0057
260 E / 280 E (E 280)	10 61 0043	10 61 0044	10 61 0057	300 D / D Turbo (E 300)	10 61 0043	10 61 0044	10 61 0057
300 E / E-24 / 320 E (E 320)	10 61 0043	10 61 0044	10 61 0057				



(1) (ex.) 320 E (E 320) / E36 AMG

(3) (ch.) B 711096 → C 018227

(2) (ch.) → B 711095
(ch.) C 018228 →

(4) 320 E (E 320) / E36 AMG



Ref. - No.



10 56 0001	201 330 00 18	Rep. Satz Exzenterbolzen / rep. kit eccentric pin		M14x1,5x130
10 60 0019	201 330 01 75	Rep. Satz Querlenker / rep. kit control arm	(2)	
10 60 0021	124 330 09 75	Rep. Satz Querlenker / rep. kit control arm	(3)	
10 61 0043	124 323 51 85	Stabilisatorlager / stabilizer mount		☒ I 22,5
10 61 0044	124 323 45 85	Stabilisatorlager / stabilizer mount		☒ I 27,5
10 61 0045	124 323 44 85	Stabilisatorlager / stabilizer mount		☒ I 25
10 61 0056	124 323 44 85 S2	Rep. Satz Stabilisatorlager / rep. kit stabilizer mount	(1) / (ch.) C 018228 →	
10 61 0057	124 323 45 85 S2	Rep. Satz Stabilisatorlager / rep. kit stabilizer mount	(1) / (ch.) C 018228 →	
10 73 0014	124 330 30 07	Querlenker / control arm	(1) / (ch.) → C 018227	
10 73 0015	124 330 31 07	Querlenker / control arm	(1) / (ch.) → C 018227	
10 73 0019	201 330 40 07	Querlenker / control arm	(4) / (ch.) C 018228 →	
10 73 0022	201 330 41 07	Querlenker / control arm	(4) / (ch.) C 018228 →	
10 73 0026	124 330 34 07	Querlenker / control arm	(1)	☒ A 18
10 73 0027	124 330 35 07	Querlenker / control arm		
10 78 0005	124 333 03 27	Traggelenk / ball joint		



BM 124 (E-Klasse) (1985 → 1995)

Quality Made For The World

Limousine 400 E (E 420) → 500 E (E 500)

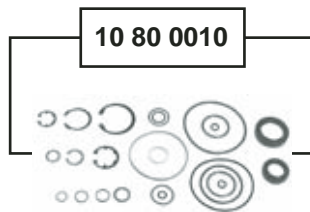

10 80 0010

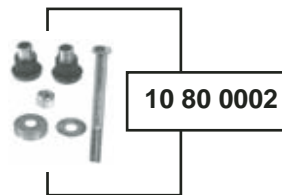

10 80 0002

10 52 0003

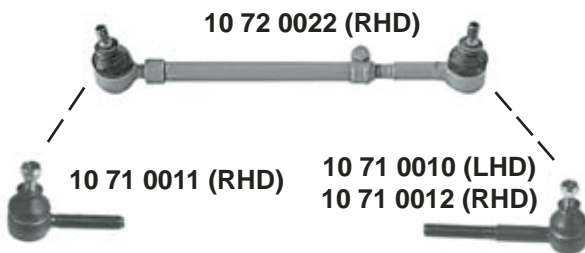

10 72 0022 (RHD)

10 71 0011 (RHD)

10 71 0010 (LHD)
10 71 0012 (RHD)

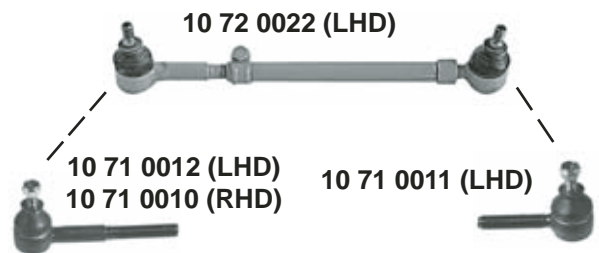

10 72 0022 (LHD)

10 71 0012 (LHD)
10 71 0010 (RHD)

10 71 0011 (LHD)



Ref. - No.



10 52 0003	124 463 04 32	Lenkungsämpfer / steering damper	
10 71 0010	001 330 70 35	Spurstangenendstück / tie rod end	M14x1,5 LHT
10 71 0011	001 330 54 35	Spurstangenendstück / tie rod end	M14x1,5 RHT
10 71 0012	001 330 55 35	Spurstangenendstück / tie rod end	M14x1,5 LHT
10 72 0022	129 330 03 03	Spurstange / tie rod	
10 80 0008	129 460 00 19	Rep. Satz Lenkhebel / rep. kit steering arm	
10 80 0010	124 460 79 01	Rep. Satz Servolenkung / rep. kit power steering	



BM 124 (E-Klasse) (1985 → 1995)

Limousine 400 E (E 420) → 500 E (E 500)

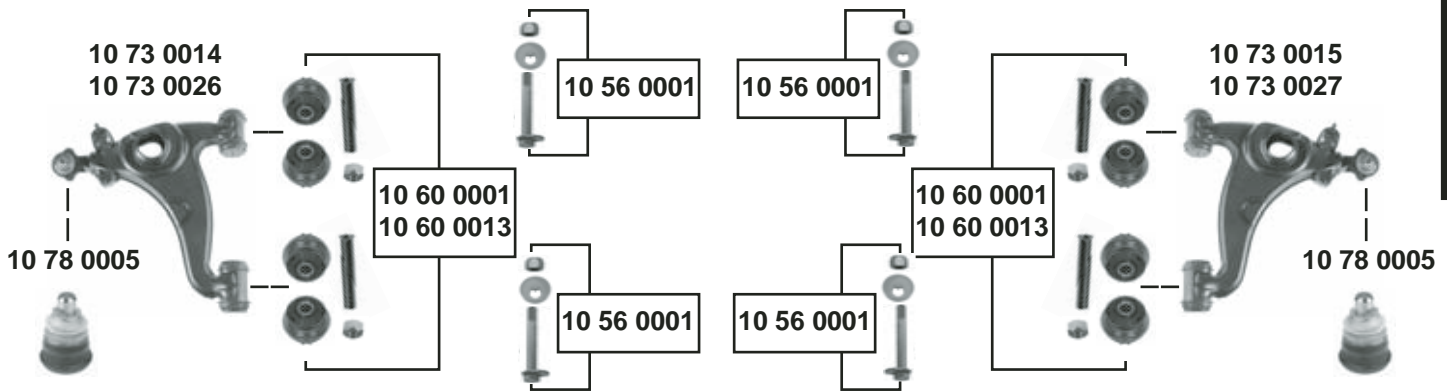
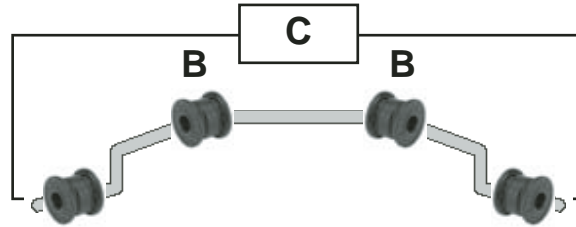

Stabilisatorlager / stabilizer mounts

	A	B	C		A	B	C
400 E (E 420) (ex.) Sport	10 61 0036	10 61 0035	-	500 E (E 500)	-	10 61 0043	-
400 E (E 420) Sport	-	10 61 0043	-				



(1) 500 E (E 500) (ch.) → B 927760

(2) 400 E (E 420) alle / all
500 E (E 500) (ch.) B 927761 →



Ref. - No.



10 56 0001	201 330 00 18	Rep. Satz Exzenterbolzen / rep. kit eccentric pin		M14x1,5x130
10 60 0001	124 330 05 75	Rep. Satz Querlenker / rep. kit control arm	(ch.) → B 711095	
10 60 0013	124 330 06 75	Rep. Satz Querlenker / rep. kit control arm	(ch.) B 711096 →	
10 61 0035	124 323 56 85	Stabilisatorlager / stabilizer mount		∅ I 26,5
10 61 0036	124 323 50 85	Stabilisatorlager / stabilizer mount		∅ I 22,5
10 61 0043	124 323 51 85	Stabilisatorlager / stabilizer mount		
10 73 0014	124 330 30 07	Querlenker / control arm	(1)	
10 73 0015	124 330 31 07	Querlenker / control arm	(1)	
10 73 0026	124 330 34 07	Querlenker / control arm	(2)	
10 73 0027	124 330 35 07	Querlenker / control arm	(2)	
10 78 0005	124 333 03 27	Traggelenk / ball joint	(1)	∅ A 18

BM 124 (E-Klasse) Coupé (1985 → 1995)

(ex.) **Sport**

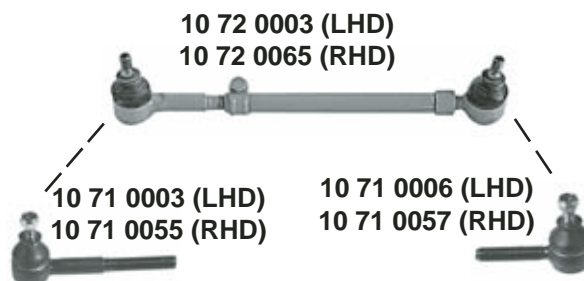
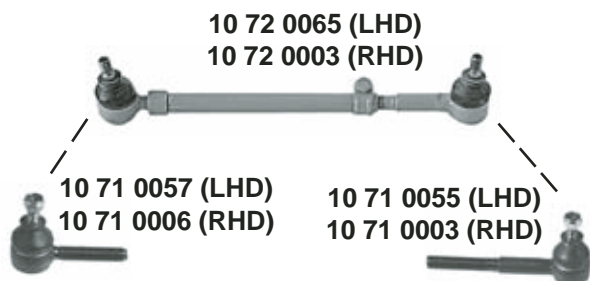
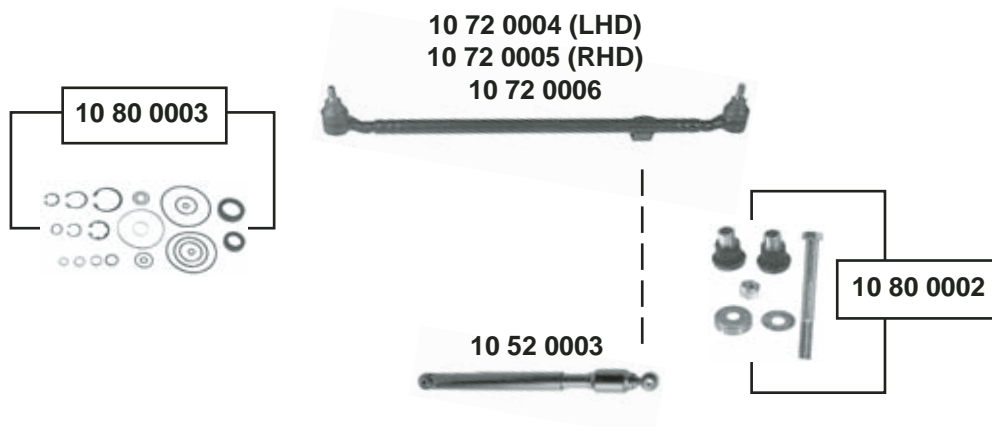

	Ref. - No.			
10 52 0003	124 463 04 32	Lenkungsdämpfer / steering damper		
10 71 0003	000 338 59 10	Spurstangenendstück / tie rod end		M14x1,5 LHT
10 71 0006	000 338 54 10	Spurstangenendstück / tie rod end		M14x1,5 RHT
10 71 0055	000 338 56 10	Spurstangenendstück / tie rod end		M14x1,5 LHT
10 71 0057	000 338 51 10	Spurstangenendstück / tie rod end		M14x1,5 RHT
10 72 0003	124 330 09 03	Spurstange / tie rod		
10 72 0004	124 460 08 05	Lenkstange / drag link	(ch.) → 1B 022104	
10 72 0005	124 460 09 05	Lenkstange / drag link	(ch.) → 2B 051198	
10 72 0006	124 460 12 05	Lenkstange / drag link	(ch.) 1B 022105 →	
10 72 0006	124 460 12 05	Lenkstange / drag link	(ch.) 2B 511199 →	
10 72 0065	124 330 08 03	Spurstange / tie rod		
10 80 0002	124 460 01 19	Rep. Satz Lenkhebel / rep. kit steering arm		
10 80 0003	124 460 01 61	Rep. Satz Servolenkung / rep. kit power steering		



BM 124 (E-Klasse)
(1985 → 1995)

Coupé
(ex.) **Sport**

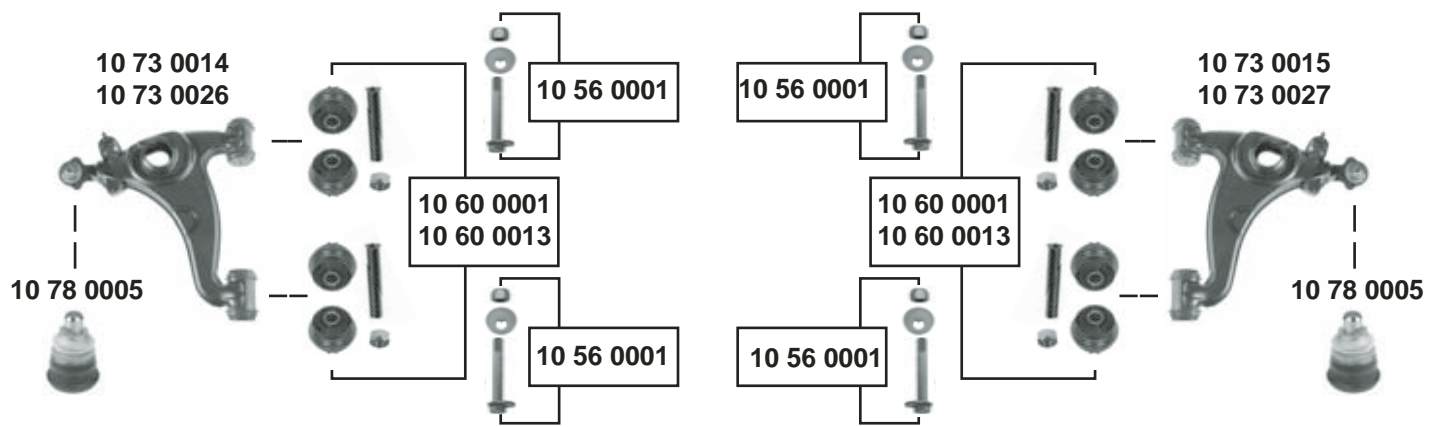
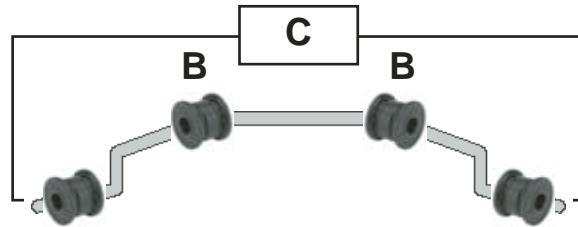

Stabilisatorlager / stabilizer mounts

	A	B	C		A	B	C
200 CE (E 200)	10 61 0032	10 61 0041	10 61 0054	300 CE / CE-24	10 61 0032	10 61 0035	10 61 0055
220 CE (E 220)	10 61 0032	10 61 0041	10 61 0054	320 CE (E 320)	10 61 0032	10 61 0035	10 61 0055
230 CE	10 61 0032	10 61 0033	10 61 0030				



(1) 200 CE (E 200) / 220 CE (E 220)
230 CE / 300 CE

(2) 300 CE -24 / 320 CE (E 320)
AMG 300 CE 3.4 / E36 AMG



Ref. - No.



10 56 0001	201 330 00 18	Rep. Satz Exzenterbolzen / rep. kit eccentric pin		M14x1,5x130
10 60 0001	124 330 05 75	Rep. Satz Querlenker / rep. kit control arm	(ch.) → B 711095	
10 60 0013	124 330 06 75	Rep. Satz Querlenker / rep. kit control arm	(ch.) B 711096 →	
10 61 0030	124 320 21 47	Rep. Satz Stabilisatorlager / rep. kit stabilizer mount		
10 61 0032	124 323 49 85	Stabilisatorlager / stabilizer mount		☒ I 18
10 61 0033	124 323 37 85	Stabilisatorlager / stabilizer mount		☒ I 24
10 61 0035	124 323 56 85	Stabilisatorlager / stabilizer mount		☒ I 26,5
10 61 0041	124 323 54 85	Stabilisatorlager / stabilizer mount		☒ I 24
10 61 0054	124 323 54 85 S1	Rep. Satz Stabilisatorlager / rep. kit stabilizer mount		
10 61 0055	124 323 56 85 S1	Rep. Satz Stabilisatorlager / rep. kit stabilizer mount		
10 73 0014	124 330 30 07	Querlenker / control arm	(1)	
10 73 0015	124 330 31 07	Querlenker / control arm	(1)	
10 73 0026	124 330 34 07	Querlenker / control arm	(2)	
10 73 0027	124 330 35 07	Querlenker / control arm	(2)	
10 78 0005	124 333 03 27	Traggelenk / ball joint	(1)	☒ A 18

BM 124 (E-Klasse) Coupé (1985 → 1995) **Sport**

Quality Made For The World



10 72 0004 (LHD)
10 72 0005 (RHD)
10 72 0006

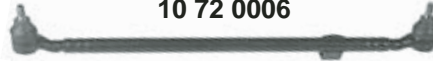

10 80 0003

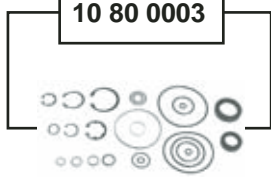

10 52 0003



10 80 0002

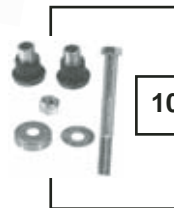

10 72 0065 (LHD)
10 72 0003 (RHD)

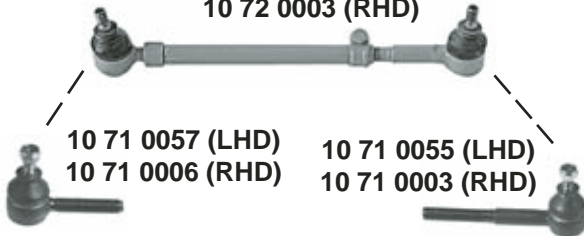

10 71 0057 (LHD)
10 71 0006 (RHD)

10 71 0055 (LHD)
10 71 0003 (RHD)

10 72 0003 (LHD)
10 72 0065 (RHD)

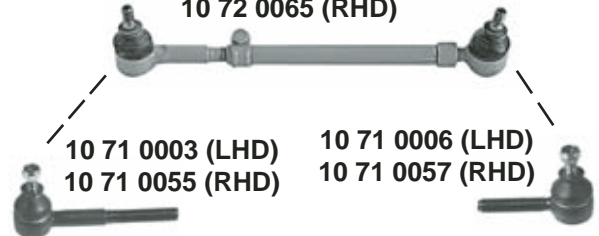

10 71 0003 (LHD)
10 71 0055 (RHD)

10 71 0006 (LHD)
10 71 0057 (RHD)



Ref. - No.



10 52 0003	124 463 04 32	Lenkungsdämpfer / steering damper	
10 71 0003	000 338 59 10	Spurstangenendstück / tie rod end	M14x1,5 LHT
10 71 0006	000 338 54 10	Spurstangenendstück / tie rod end	M14x1,5 RHT
10 71 0055	000 338 56 10	Spurstangenendstück / tie rod end	M14x1,5 LHT
10 71 0057	000 338 51 10	Spurstangenendstück / tie rod end	M14x1,5 RHT
10 72 0003	124 330 09 03	Spurstange / tie rod	
10 72 0004	124 460 08 05	Lenkstange / drag link	(ch.) → 1B 022104
10 72 0005	124 460 09 05	Lenkstange / drag link	(ch.) → 2B 051198
10 72 0006	124 460 12 05	Lenkstange / drag link	(ch.) 1B 022105 →
10 72 0006	124 460 12 05	Lenkstange / drag link	(ch.) 2B 511199 →
10 72 0065	124 330 08 03	Spurstange / tie rod	
10 80 0002	124 460 01 19	Rep. Satz Lenkhebel / rep. kit steering arm	
10 80 0003	124 460 01 61	Rep. Satz Servolenkung / rep. kit power steering	



BM 124 (E-Klasse) (1985 → 1995)

Coupé
Sport

Quality Made For The World

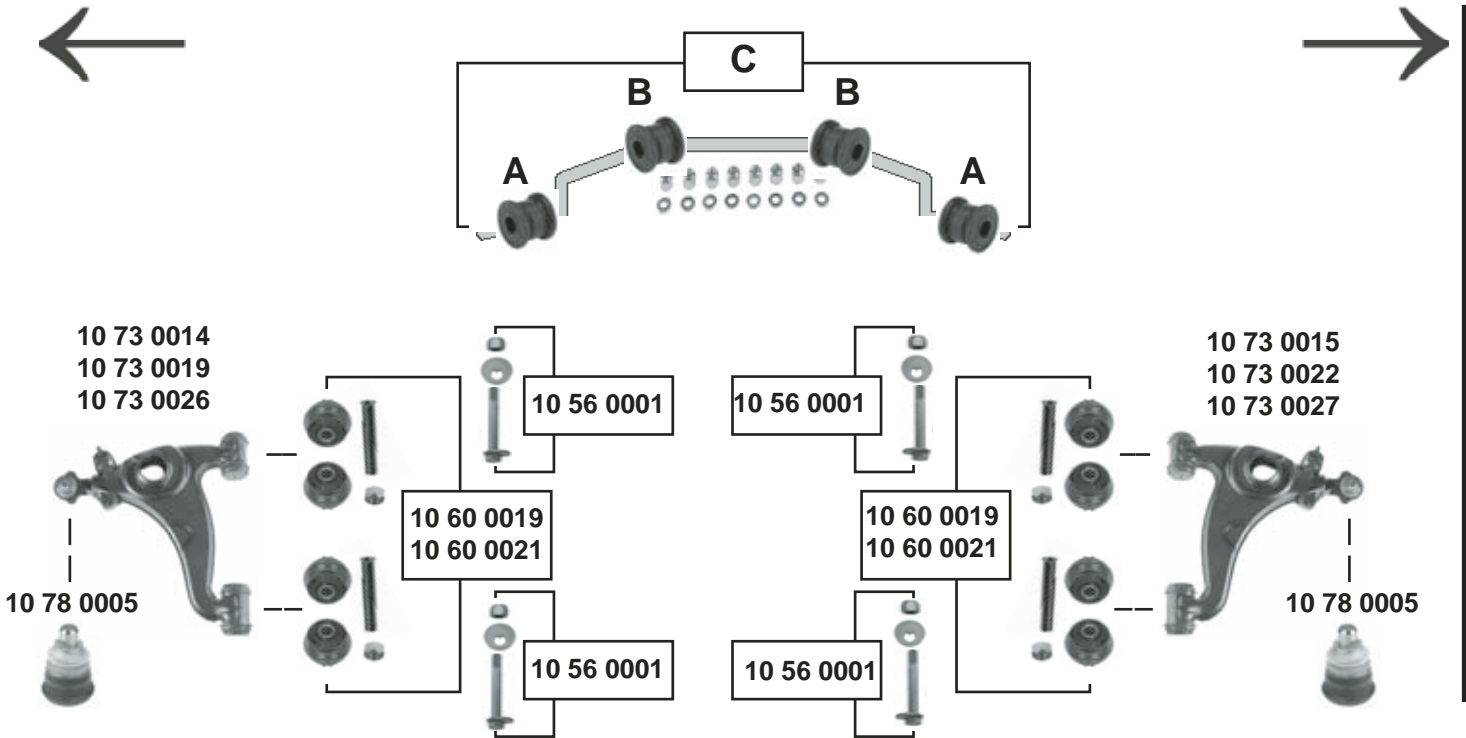

Stabilisatorlager / stabilizer mounts

	A	B	C		A	B	C
200 CE (E 200)	10 61 0043	10 61 0045	10 61 0056	300 CE / CE-24	10 61 0043	10 61 0044	10 61 0057
220 CE (E 220) / 230 CE	10 61 0043	10 61 0045	10 61 0056	320 CE (E 320)	10 61 0043	10 61 0044	10 61 0057



(1) 200 CE (E 200) / 220 CE (E 220)
230 CE / 300 CE

(3) (ch.) B 711096 → C 017668

(2) (ch.) → B 711095
(ch.) C 017669 →

(4) 320 CE (E 320) / E 36 AMG



Ref. - No.



10 56 0001	201 330 00 18	Rep. Satz Exzenterbolzen / rep. kit eccentric pin		M14x1,5x130
10 60 0019	201 330 01 75	Rep. Satz Querlenker / rep. kit control arm	(2)	
10 60 0021	124 330 09 75	Rep. Satz Querlenker / rep. kit control arm	(3)	
10 61 0043	124 323 51 85	Stabilisatorlager / stabilizer mount		☒ I 22,5
10 61 0044	124 323 45 85	Stabilisatorlager / stabilizer mount		☒ I 27,5
10 61 0045	124 323 44 85	Stabilisatorlager / stabilizer mount		☒ I 25
10 61 0056	124 323 44 85 S2	Rep. Satz Stabilisatorlager / rep. kit stabilizer mount		
10 61 0057	124 323 45 85 S2	Rep. Satz Stabilisatorlager / rep. kit stabilizer mount		
10 73 0014	124 330 30 07	Querlenker / control arm	(1) / (ch.) C 018228 →	
10 73 0015	124 330 31 07	Querlenker / control arm	(1) / (ch.) C 018228 →	
10 73 0019	201 330 40 07	Querlenker / control arm	(1) / (ch.) → C 018227	
10 73 0022	201 330 41 07	Querlenker / control arm	(1) / (ch.) → C 018227	
10 73 0026	124 330 34 07	Querlenker / control arm	(4) / (ch.) C 017669 →	
10 73 0027	124 330 35 07	Querlenker / control arm	(4) / (ch.) C 017669 →	
10 78 0005	124 333 03 27	Traggelenk / ball joint	(1)	☒ A 18

BM 124 (E-Klasse) Cabrio (1985 → 1995)

Quality Made For The World

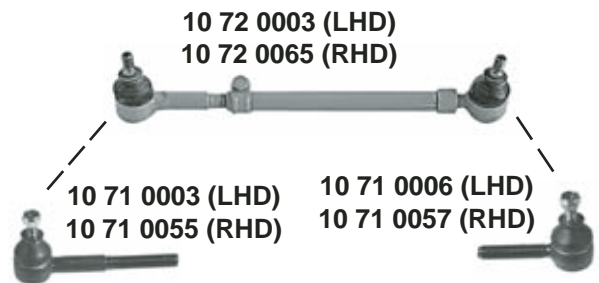
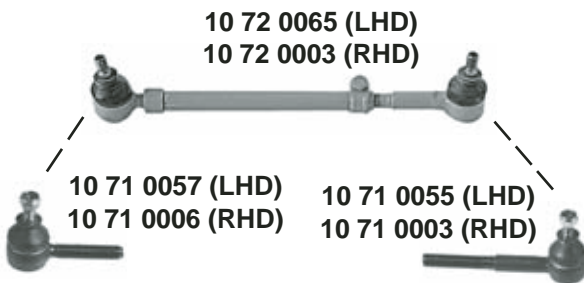
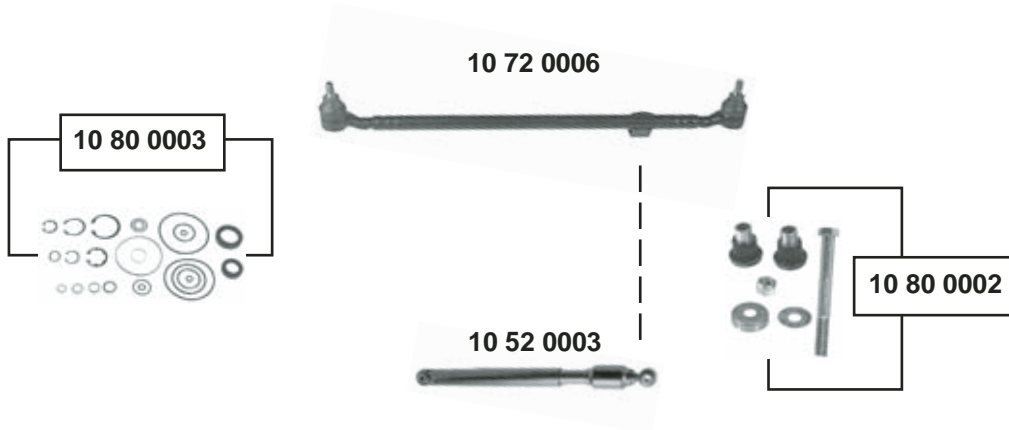

Ref. - No.



Ref. - No.			
10 52 0003	124 463 04 32	Lenkungsdämpfer / steering damper	
10 71 0055	000 338 56 10	Spurstangenendstück / tie rod end	M14x1,5 LHT
10 71 0003	000 338 59 10	Spurstangenendstück / tie rod end	M14x1,5 LHT
10 71 0006	000 338 54 10	Spurstangenendstück / tie rod end	M14x1,5 RHT
10 71 0057	000 338 51 10	Spurstangenendstück / tie rod end	M14x1,5 RHT
10 72 0003	124 330 09 03	Spurstange / tie rod	
10 72 0006	124 460 12 05	Lenkstange / drag link	
10 72 0065	124 330 08 03	Spurstange / tie rod	
10 80 0002	124 460 01 19	Rep. Satz Lenkhebel / rep. kit steering arm	
10 80 0003	124 460 01 61	Rep. Satz Servolenkung / rep. kit power steering	



BM 124 (E-Klasse)
(1985 → 1995)

Cabrio

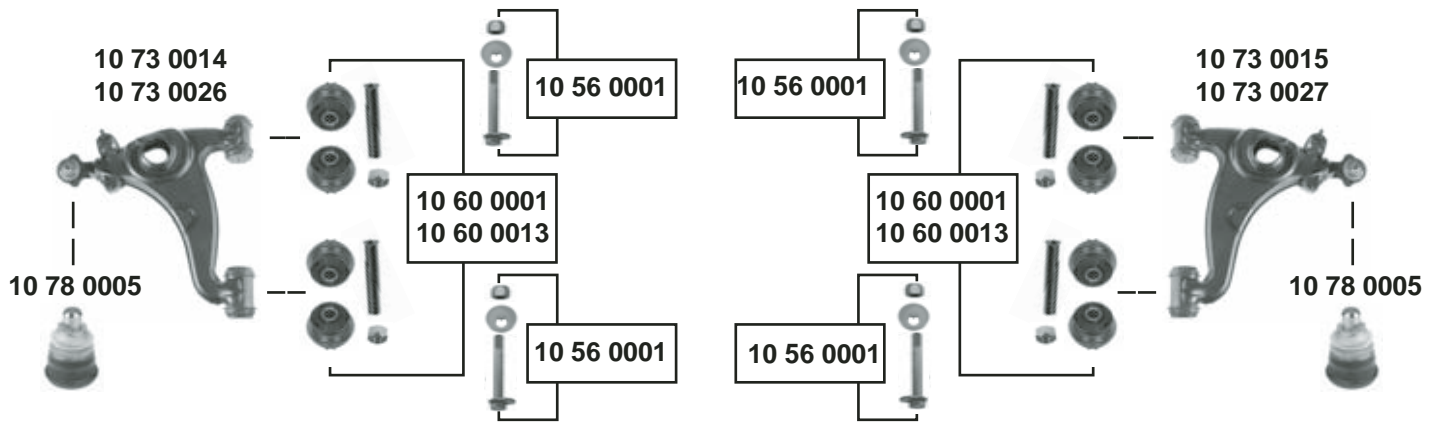
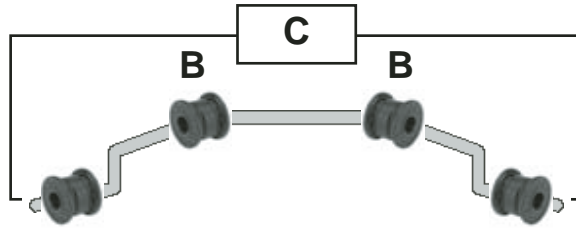

Stabilisatorlager / stabilizer mounts

	A	B	C		A	B	C
(ex.) Sport	10 61 0043	10 61 0044	10 61 0057	Sport	10 61 0043	10 61 0046	-



(1) 200 E Cabrio (E 200)
220 E Cabrio (E 220)

(2) 300 CE -24 Cabrio / 320 E Cabrio (E 320)
E36 AMG Cabrio



Ref. - No.



10 56 0001	201 330 00 18	Rep. Satz Exzenterbolzen / rep. kit eccentric pin		M14x1,5x130
10 60 0001	124 330 05 75	Rep. Satz Querlenker / rep. kit control arm	(ch.) → B 711095	
10 60 0013	124 330 06 75	Rep. Satz Querlenker / rep. kit control arm	(ch.) B 711096 →	
10 61 0043	124 323 51 85	Stabilisatorlager / stabilizer mount		☒ I 22,5
10 61 0044	124 323 45 85	Stabilisatorlager / stabilizer mount		☒ I 27,5
10 61 0046	124 323 46 85	Stabilisatorlager / stabilizer mount		☒ I 28,5
10 61 0057	124 323 45 85 S2	Rep. Satz Stabilisatorlager / rep. kit stabilizer mount		
10 73 0014	124 330 30 07	Querlenker / control arm	(1)	
10 73 0015	124 330 31 07	Querlenker / control arm	(1)	
10 73 0026	124 330 34 07	Querlenker / control arm	(2)	
10 73 0027	124 330 35 07	Querlenker / control arm	(2)	
10 78 0005	124 333 03 27	Traggelenk / ball joint	(1)	☒ A 18

BM 124 (E-Klasse) T-Modell (1985 → 1995) (ex.) 4-matic

Quality Made For The World

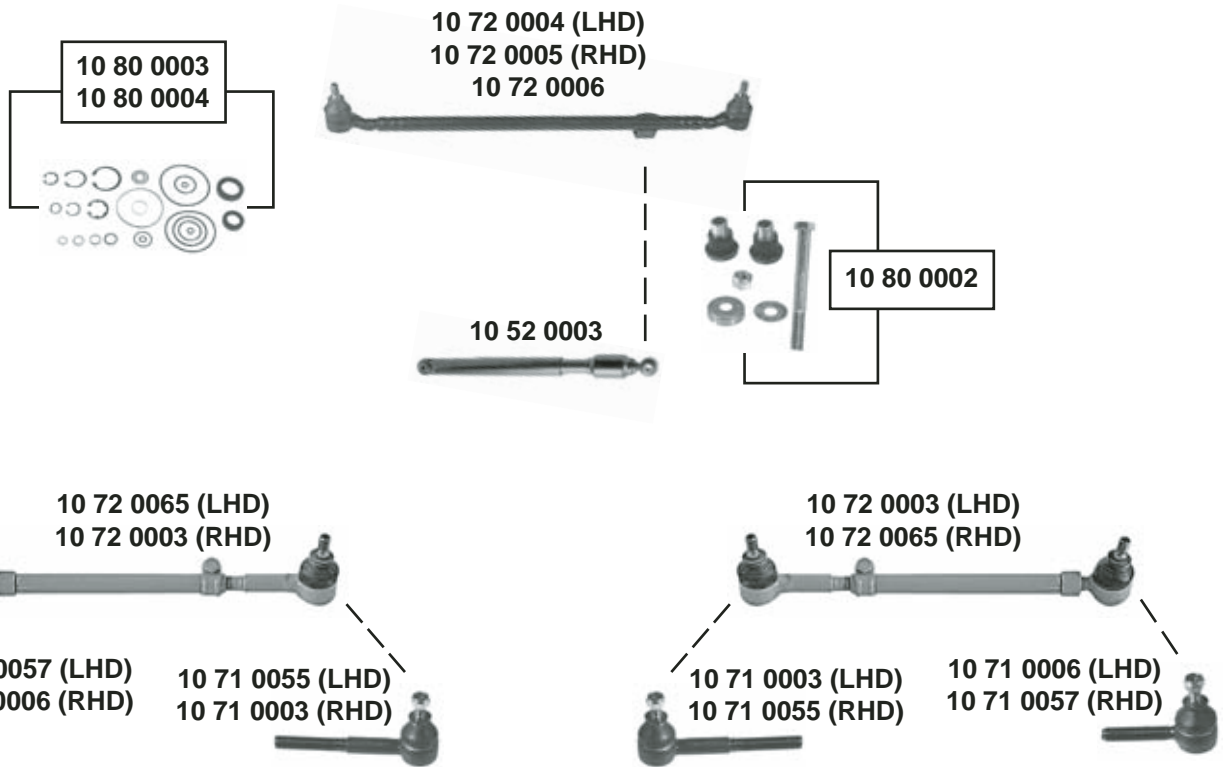

(1) 260 TE / 280 TE (E 280) / 300 TE / 300 TE-24
320 TE (E 320)
250 TD (E 250) / 250 TD Turbo (E 250)
300 TD (E 300) / 300 TD Turbo (E 300)

(2) 200 T / 200 TE (E 200) / 220 TE (E 220) / 230 TE
200 TD (E 200)

	Ref. - No.			
10 52 0003	124 463 04 32	Lenkungsdämpfer / steering damper		
10 71 0003	000 338 59 10	Spurstangenendstück / tie rod end		M14x1,5 LHT
10 71 0006	000 338 54 10	Spurstangenendstück / tie rod end		M14x1,5 RHT
10 71 0055	000 338 56 10	Spurstangenendstück / tie rod end		M14x1,5 LHT
10 71 0057	000 338 51 10	Spurstangenendstück / tie rod end		M14x1,5 RHT
10 72 0003	124 330 09 03	Spurstange / tie rod		
10 72 0004	124 460 08 05	Lenkstange / drag link	(ch.) → 1F 114568	
10 72 0005	124 460 09 05	Lenkstange / drag link	(ch.) → 2F 120743	
10 72 0006	124 460 12 05	Lenkstange / drag link	(ch.) 1F 114569 →	
10 72 0006	124 460 12 05	Lenkstange / drag link	(ch.) 2F 120744 →	
10 72 0065	124 330 08 03	Spurstange / tie rod		
10 80 0002	124 460 01 19	Rep. Satz Lenkhebel / rep. kit steering arm		
10 80 0003	124 460 01 61	Rep. Satz Servolenkung / rep. kit power steering	(1)	
10 80 0004	201 460 00 61	Rep. Satz Servolenkung / rep. kit power steering	(2)	



BM 124 (E-Klasse)
(1985 → 1995)

T-Modell
(ex.) 4-matic

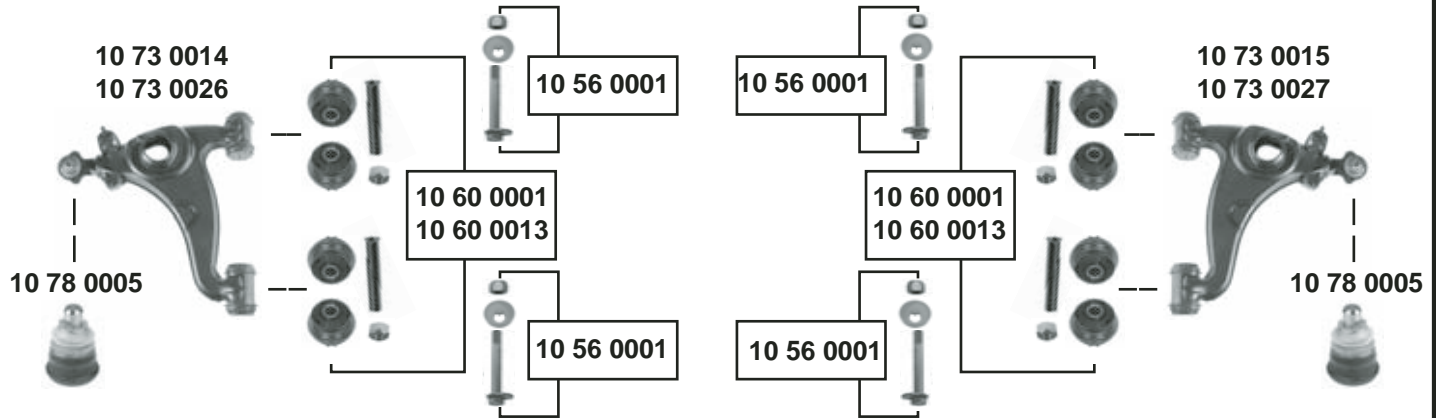
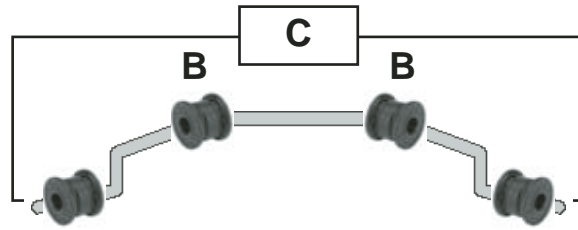

Stabilisatorlager / stabilizer mountings

		A	B	C			A	B	C
200 T / 200 TE (E 200)	(ex.) Sport	10 61 0036	10 61 0045	10 61 0058	200 TD (E 200)	(ex.) Sport	10 61 0036	10 61 0045	10 61 0058
220 TE (E 220) / 230 TE	(ex.) Sport	10 61 0036	10 61 0045	10 61 0058	250 TD / TD Turbo (E 250)	(ex.) Sport	10 61 0036	10 61 0044	10 61 0059
280 TE (E 200) / 300 TE	(ex.) Sport	10 61 0036	10 61 0044	10 61 0059	300 TD / TD Turbo (E 300)	(ex.) Sport	10 61 0036	10 61 0044	10 61 0059
300 TE-24 / 320 TE (E 320)	(ex.) Sport	10 61 0032	10 61 0044	10 61 0059	alle / all	Sport	10 61 0043	10 61 0046	10 61 0060
alle / all	Sport	10 61 0043	10 61 0046	10 61 0060					



(1) (ex.) 300 TE -24 / 320 TE (E 320)
(ex.) AMG 300 TE 3.4 / E36 AMG

(2) 300 TE -24 / 320 TE (E 320)
AMG 300 TE 3.4 / E36 AMG



Ref. - No.



10 56 0001	201 330 00 18	Rep. Satz Exzenterbolzen / rep. kit eccentric pin		M14x1,5x130
10 60 0001	124 330 05 75	Rep. Satz Querlenker / rep. kit control arm	(ch.) → F 204091	
10 60 0013	124 330 06 75	Rep. Satz Querlenker / rep. kit control arm	(ch.) F 204092 →	
10 61 0032	124 323 49 85	Stabilisatorlager / stabilizer mount		☒ I 18
10 61 0036	124 323 50 85	Stabilisatorlager / stabilizer mount		☒ I 22,5
10 61 0043	124 323 51 85	Stabilisatorlager / stabilizer mount		☒ I 22,5
10 61 0044	124 323 45 85	Stabilisatorlager / stabilizer mount		☒ I 27,5
10 61 0045	124 323 44 85	Stabilisatorlager / stabilizer mount		☒ I 25
10 61 0046	124 323 46 85	Stabilisatorlager / stabilizer mount		☒ I 28,5
10 61 0058	124 323 44 85 S1	Rep. Satz Stabilisatorlager / rep. kit stabilizer mount	(1)	
10 61 0059	124 323 45 85 S1	Rep. Satz Stabilisatorlager / rep. kit stabilizer mount	(1)	
10 61 0060	124 323 46 85 S1	Rep. Satz Stabilisatorlager / rep. kit stabilizer mount	(2)	
10 73 0014	124 330 30 07	Querlenker / control arm	(2)	
10 73 0015	124 330 31 07	Querlenker / control arm	(2)	
10 73 0026	124 330 34 07	Querlenker / control arm	(1)	
10 73 0027	124 330 35 07	Querlenker / control arm	(1)	
10 78 0005	124 333 03 27	Traggelenk / ball joint	(1)	☒ A 18

BM 124 (E-Klasse) (1985 → 1995) 4-matic

Quality Made For The World

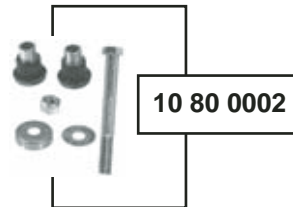
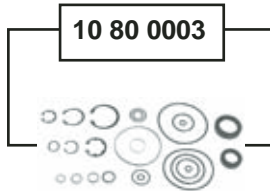

10 71 0019 (LHD)

10 71 0017 (LHD)
10 71 0021 (RHD)

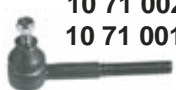

10 71 0021 (LHD)
10 71 0017 (RHD)

10 71 0020 (LHD)
10 71 0016 (RHD)



Ref. - No.



10 71 0016	001 330 43 35	Spurstangenendstück / tie rod end	M14x1,5 LHT
10 71 0017	001 330 41 35	Spurstangenendstück / tie rod end	M14x1,5 RHT
10 71 0019	001 330 38 35	Spurstangenendstück / tie rod end	M14x1,5 LHT
10 71 0020	001 330 39 35	Spurstangenendstück / tie rod end	M14x1,5 LHT
10 71 0021	001 330 40 35	Spurstangenendstück / tie rod end	M14x1,5 RHT
10 80 0002	124 460 01 19	Rep. Satz Lenkhebel / rep. kit steering arm	
10 80 0003	124 460 01 61	Rep. Satz Servolenkung / rep. kit power steering	
10 92 1292	124 330 14 03	Spurstange / tie rod	
10 92 1293	124 330 15 03	Spurstange / tie rod	

passend für / to fit

MERCEDES BENZ



BM 124 (E-Klasse) (1985 → 1995)

4-matic

Quality Made For The World

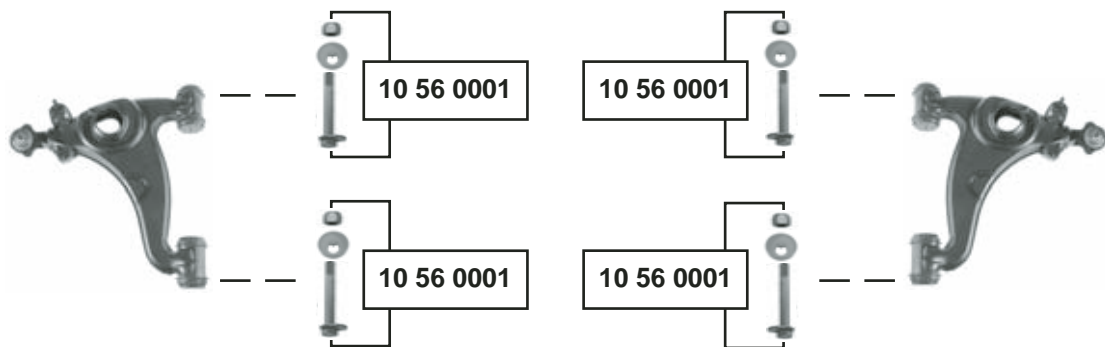

Ref. - No.



10 56 0001

201 330 00 18

Rep. Satz Exzenterbolzen / rep. kit eccentric pin

M14x1,5x130